

规格书

WWT230-06-78

6M 工业镜头

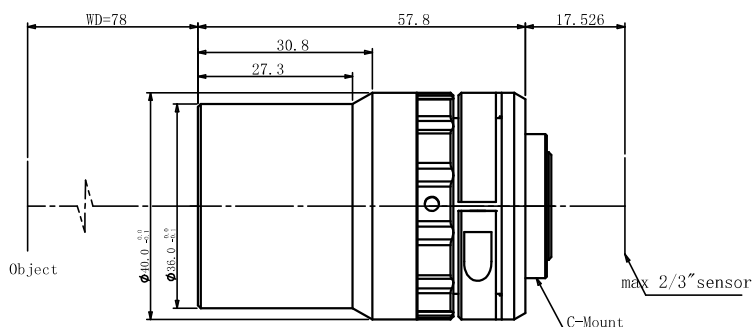

光学参数

放大倍率 β (x)	0.6
物方工作距 WD (mm)	78
支持 CCD 尺寸 (Φ mm)	11.0(2/3")
像方 F/#	7.0
焦距 (mm)	39.32
数值孔径 NA	0.04287
物方分辨率 (μ m)	7.8
物方景深 DoF (mm)	1.6
像方 MTF30 (lp/mm)	114
TV 畸变 (%)	-0.0239

视野范围 (mm × mm)

1/1.8" (7.13x5.37)	11.88x8.95
1/1.8" (7.43x4.9)	12.38x8.17
2/3" (8.45x7.1)	14.1x11.8

机械参数

相机接口	C
镜头总长 (mm)	57.8
是否同轴光 / 可调光栏	否 / 否

